

FEATURES

- ▶ Industrial Standard Quarter Brick Package
- ▶ Ultra-wide Input Range 36-160VDC
- ▶ I/O Isolation 2000VAC with Reinforced Insulation
- ▶ Excellent Efficiency up to 90%
- ▶ Operating Baseplate Temp. Range -40°C to +105°C
- ▶ No Min. Load Requirement
- ▶ Under-voltage, Overload/Voltage/Temp. and Short Circuit Protection
- ▶ Remote On/Off Control, Output Voltage Trim, Output Sense
- ▶ Vibration and Shock/Bump Test EN 61373 Approved
- ▶ Cooling, Dry & Damp Heat Test IEC/EN 60068-2-1, 2, 30 Approved
- ▶ Railway EMC Standard EN 50121-3-2 Approved
- ▶ Railway Certified EN 50155 (IEC60571) Approved
- ▶ Fire Protection Test EN 45545-2 Approved
- ▶ UL/cUL/IEC/EN 62368-1 Safety Approval & CE Marking

NEW

PRODUCT OVERVIEW

The MINMAX MRZI150 series is a new generation of high performance 150W DC-DC converters in quarter brick package designed specifically for railway applications with popular 36-160 VDC input ranges. MRZI150 is approved by railway industry standard EN 50155 and complies with EMC standard EN 50121-3-2.

Advanced circuit topology provides a very high efficiency up to 90% which allows baseplate temperature up to 105°C and very high I/O isolation up to 2000VAC with reinforced insulation which are designed to meet stringent requirements and harsh environment.

Further product features include under-voltage, overload/voltage/temp., short circuit protection, remote On/Off Control(positive/negative logic), output voltage trim, output sense and complies specifically fire protection test meets EN45545-2 to ensure safety during railway/railroad vehicle operation.

Model Selection Guide

Model Number	Input Voltage (Range) ⁽¹⁰⁾	Output Voltage	Output Power	Output Current	Input Current		Over Voltage Protection	Max. capacitive Load	Efficiency (typ.)
					@Max. Load	@No Load			
	VDC	VDC	W	A	mA(typ.)	mA(typ.)	VDC	µF	%
MRZI150-110S05	110 (36 ~ 160)	5	135	27	1364	10	6.2	51000	90
MRZI150-110S12		12	150	12.5	1515	10	15	8850	90
MRZI150-110S15		15	150	10	1532	10	18	5700	89
MRZI150-110S24		24	150	6.25	1550	10	30	2200	88
MRZI150-110S54		54	150.12	2.78	1542	10	66	550	88.5

Input Specifications

Parameter	Min.	Typ.	Max.	Unit
Input Voltage Range ⁽¹⁰⁾	36	110	160	VDC
Input Surge Voltage (100ms. max)	-0.7	---	170	
Start-up Threshold Voltage	---	---	36	
Under Voltage Shutdown	---	35	---	
Input Filter	Internal Capacitor			

Output Specifications							
Parameter		Conditions		Min.	Typ.	Max.	Unit
Output Voltage Setting Accuracy				---	---	±1.0	%
Line Regulation		Vin=Min. to Max. @ Full Load		---	---	±0.2	%
Load Regulation		Min. Load to Full Load		---	---	±0.3	%
Min.Load		No minimum Load Requirement					
Ripple & Noise	0-20 MHz Bandwidth	5V Output	Measured with a 22uF/25V POLYMER	---	100	---	mV _{p-p}
		12V, 15V Output		---	150	---	mV _{p-p}
		24V Output	Measured with a 33uF/35V POLYMER	---	200	---	mV _{p-p}
		54V Output	Measured with a 1uF/100V MLCC	---	300	---	mV _{p-p}
Start-up Time (Power On)				---	50	---	mS
Transient Recovery Time		25% Load Step Change (4)		---	250	---	µsec
Transient Response Deviation				---	±3	±5	%
Temperature Coefficient				---	---	±0.02	%/°C
Trim Up / Down Range (9)		% of Nominal Output Voltage		---	---	±10	%
		Other Models 54V Output		---	---	+5 / -15	%
Over Load Protection (8)		Current Limitation at 150% typ. of Iout max., Hiccup					
Short Circuit Protection		Hiccup Mode 0.3 Hz typ., Automatic Recovery					

General Specifications							
Parameter		Conditions		Min.	Typ.	Max.	Unit
I/O Isolation Voltage		Reinforced Insulation, Rated For 60 Seconds		2000	---	---	VAC
Isolation Voltage	Input to case			1500	---	---	VAC
	Output to case			500	---	---	VAC
I/O Isolation Resistance		500 VDC		10	---	---	GΩ
I/O Isolation Capacitance		100kHz, 1V		---	2000	---	pF
Switching Frequency		Other Models		---	200	---	kHz
		54V Output		---	180	---	kHz
MTBF(calculated)		MIL-HDBK-217F@25°C Full Load, Ground Benign		412,541	---	---	Hours
Safety Standards		EN 50155, IEC 60571					
		UL/cUL 62368-1 recognition(UL certificate), IEC/EN 62368-1					

Remote On/Off Control							
Parameter		Conditions		Min.	Typ.	Max.	Unit
Positive logic (Standard)	Converter On	3.5V ~ 12V or Open Circuit					
	Converter Off	0V ~ 1.2V or Short Circuit					
Negative logic (Option)	Converter On	0V ~ 1.2V or Short Circuit					
	Converter Off	3.5V ~ 12V or Open Circuit					
Positive logic	Control Input Current	Converter On	Vctrl = 5.0V	---	---	0.5	mA
		Converter Off	Vctrl = 0V	---	---	-0.5	mA
Negative logic	Control Input Current	Converter On	Vctrl = 0V	---	---	-0.5	mA
		Converter Off	Vctrl = 5.0V	---	---	0.5	mA
Control Common		Referenced to Negative Input					
Standby Input Current		Nominal Vin		---	3	---	mA

EMC Specifications

Parameter	Standards & Level			Performance	
General	Compliance with EN 50121-3-2 Railway Applications				
EMI	Conduction	EN 55032/11	With external components	Class A ⁽⁵⁾	
	Radiation				
EMS	EN 55024, EN 55035				
	ESD	Direct discharge	Indirect discharge HCP & VCP		
		EN 61000-4-2 air ± 8kV, Contact ± 6kV		Contact ± 6kV	
	Radiated immunity	EN 61000-4-3 10V/m			A
	Fast transient ⁽⁶⁾	EN 61000-4-4 ±2kV			A
	Surge ⁽⁶⁾	EN 61000-4-5 ±1kV			A
	Conducted immunity	EN 61000-4-6 10Vrms			A
PFMF	EN 61000-4-8 3A/M			A	

Environmental Specifications

Parameter	Model	Min.	Typ.	Max.	Unit
Baseplate Temperature Range	MRZ1150-110S05	-40	---	+100	°C
	MRZ1150-110S12, MRZ1150-110S24, MRZ1150-110S54, MRZ1150-110S15			+105	
Over Temperature Protection (Baseplate)		---	+110	---	°C
Storage Temperature Range		-50	---	+125	°C
Cooling Test	Compliance to IEC/EN60068-2-1				
Dry Heat	Compliance to IEC/EN60068-2-2				
Damp Heat	Compliance to IEC/EN60068-2-30				
Vibration and Shock/Bump	Compliance to IEC/EN 61373				
Operating Humidity (non condensing)		5		95	% rel. H
Lead Temperature (1.5mm from case for 10Sec.)		---		260	°C

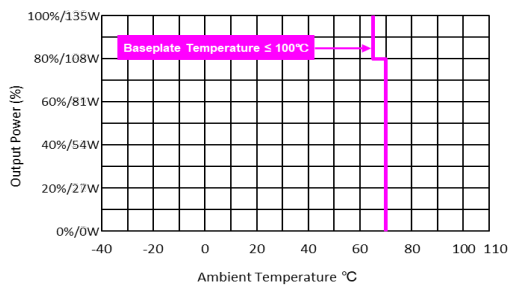
Power Derating Curve

MRZ1150-110S05

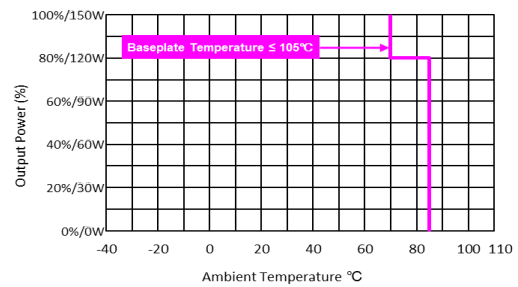

MRZ1150-110S12, MRZ1150-110S24, MRZ1150-110S54

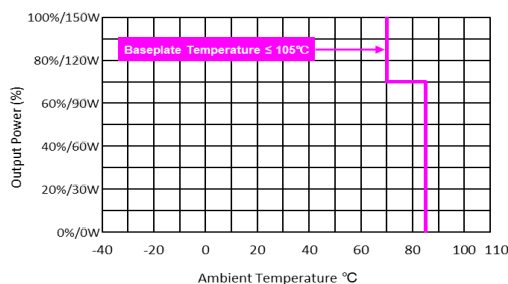

MRZ1150-110S15

* The power module can deliver full rated power as long as users keep operating baseplate temperature below 105°C within defined ambient temperature range.

Notes

- 1 Specifications typical at $T_a=+25^{\circ}\text{C}$, resistive load, nominal input voltage and rated output current unless otherwise noted.
- 2 Transient recovery time is measured to within 1% error band for a step change in output load of 75% to 100%.
- 3 Other input and output voltage may be available, please contact MINMAX.
- 4 **It is necessary to parallel a capacitor across the input pins under normal operation. Minimum Capacitance: 150 μF / 250V KXJ.**
- 5 To meet EN 55032 Class A with an external filter, please contact MINMAX.
- 6 To meet EN 61000-4-4 & EN 61000-4-5 with an external filter requested, please contact MINMAX.
- 7 **The hot-swap operation is extremely prohibited.**
- 8 Over Current Protection (OCP) is built in and works over 130% of the rated current or higher. However, use in an over current situation over 4 seconds must be avoided whenever possible.
- 9 Do not exceed maximum power specification when adjusting output voltage. Please see the External Output Trimming table at page 6.
- 10 ***Input Voltage $V_{in}=36\text{VDC}/1\text{s}$ for Start-up Operation and $V_{in}=40\text{VDC}$ for Continuous Operation.**
- 11 Specifications are subject to change without notice.

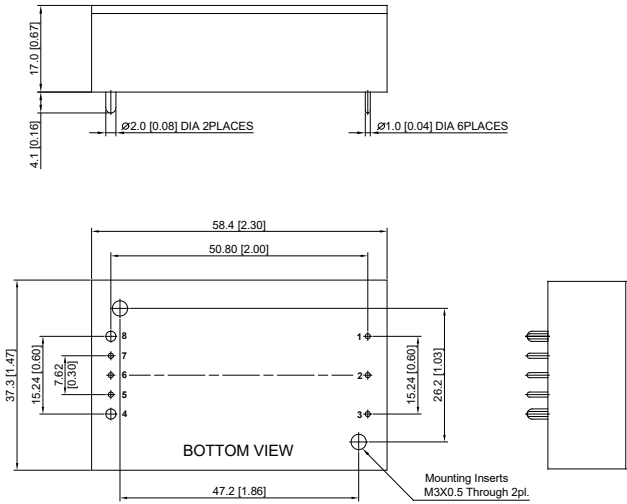
Package Specifications
Mechanical Dimensions

Pin Connections

Pin	Function
1	+Vin
2	Remote On/Off
3	-Vin
4	-Vout
5	* -Sense
6	Trim
7	* +Sense
8	+Vout

* If remote sense not used the +sense should be connected to +output and -sense should be connected to -output
 Maximum output deviation is 10% inclusive of trim

- ▶ All dimensions in mm (inches)
- ▶ Tolerance: X.X±0.5 (X.XX±0.02)
 X.XX±0.25 (X.XXX±0.01)
- ▶ Pin diameter $\varnothing 1.0 \pm 0.05$ (0.04±0.002)
- ▶ Pin diameter $\varnothing 2.0 \pm 0.05$ (0.06±0.002)

Physical Characteristics

Case Size	: 58.4x37.3x17.0 mm (2.30x1.47x0.67 inches)
Case Material	: Plastic resin (flammability to UL 94V-0 rated)
Top Side Base Material	: Aluminum Plate
Potting Material	: Silicone (UL94-V0)
Weight	: 110g

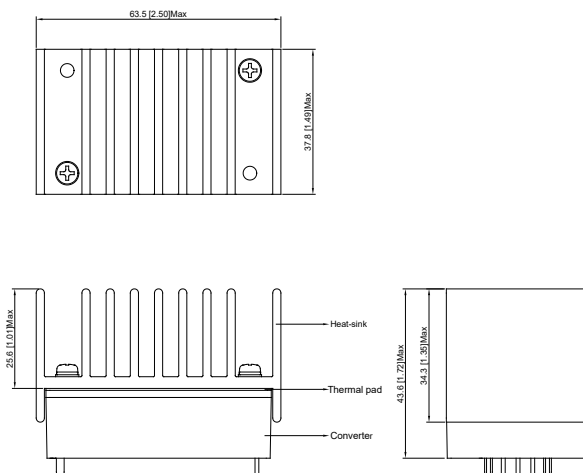
Heatsink (Option -HS7)

Physical Characteristics

Heatsink Material	: Aluminum
Finish	: Black Anodized Coating
Weight	: 63g

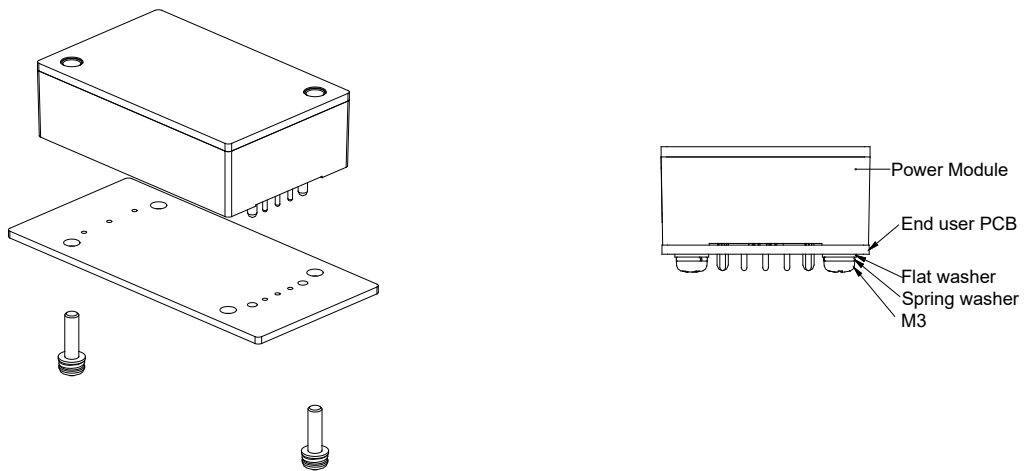
*For more power derating information, please refer to E.C Note.

PCB Installation of End Users

1. Please evaluate mechanical stress (vibration, shock, bump) during field applications.
2. It has to equip with installation kit if it exceeds the guaranteed specifications, please contact MINMAX for detail information.
3. Applied torque per screw 9 kgf.cm min.

External Output Trimming

Output can be externally trimmed by using the method shown below

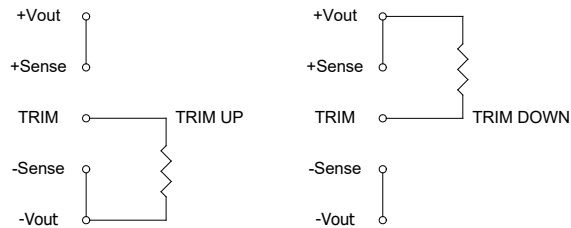

	MRZI150-110S05		MRZI150-110S12		MRZI150-110S15		MRZI150-110S24		MRZI150-110S54	
Trim Range (%)	Trim down (kΩ)	Trim up (kΩ)	Trim down (kΩ)	Trim up (kΩ)	Trim down (kΩ)	Trim up (kΩ)	Trim down (kΩ)	Trim up (kΩ)	Trim down (kΩ)	Trim up (kΩ)
1	138.88	106.87	413.55	351.00	530.73	422.77	598.66	487.14	1,882.57	560.73
2	62.41	47.76	184.55	157.50	238.61	189.89	267.78	218.02	877.94	230.36
3	36.92	28.06	108.22	93.00	141.24	112.26	157.49	128.31	543.06	120.24
4	24.18	18.21	70.05	60.75	92.56	73.44	102.34	83.46	375.62	65.18
5	16.53	12.30	47.15	41.40	63.35	50.15	69.25	56.55	275.15	32.15
6	11.44	8.36	31.88	28.50	43.87	34.63	47.19	38.61	208.18	---
7	7.79	5.55	20.98	19.29	29.96	23.54	31.44	25.79	160.34	---
8	5.06	3.44	12.80	12.37	19.53	15.22	19.62	16.18	124.46	---
9	2.94	1.79	6.44	7.00	11.41	8.75	10.43	8.70	96.55	---
10	1.24	0.48	1.35	2.70	4.92	3.58	3.08	2.72	74.23	---
11	---	---	---	---	---	---	---	---	55.96	---
12	---	---	---	---	---	---	---	---	40.74	---
13	---	---	---	---	---	---	---	---	27.86	---
14	---	---	---	---	---	---	---	---	16.82	---
15	---	---	---	---	---	---	---	---	7.25	---

Order Code Table

Standard (Positive logic)	Heatsink (Positive logic)
MRZI150-110S05	MRZI150-110S05-HS7
MRZI150-110S12	MRZI150-110S12-HS7
MRZI150-110S15	MRZI150-110S15-HS7
MRZI150-110S24	MRZI150-110S24-HS7
MRZI150-110S54	MRZI150-110S54-HS7
Negative logic	Heatsink (Negative logic)
MRZI150-110S05N	MRZI150-110S05N-HS7
MRZI150-110S12N	MRZI150-110S12N-HS7
MRZI150-110S15N	MRZI150-110S15N-HS7
MRZI150-110S24N	MRZI150-110S24N-HS7
MRZI150-110S54N	MRZI150-110S54N-HS7

Test Setup

Peak-to-Peak Output Noise Measurement Test

Use a 22 μ F polymer capacitor for 5V, 12V, 15V output models and a 33 μ F polymer capacitor for 24V output model and a 1 μ F ceramic capacitor for 54V output model. Scope measurement should be made by using a BNC socket, measurement bandwidth is 0-20 MHz. Position the load between 50 mm and 75 mm from the DC-DC Converter.

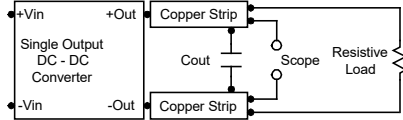

Technical Notes

Remote On/Off

Positive logic remote on/off turns the module on during a logic high voltage on the remote on/off pin, and off during a logic low. To turn the power module on and off, the user must supply a switch to control the voltage between the on/off terminal and the -Vin terminal. The switch can be an open collector or equivalent. A logic low is 0V to 1.2V. A logic high is 3.5V to 12V. The maximum sink current at the on/off terminal (Pin 2) during a logic low is -500 μ A.

Negative logic remote on/off turns the module on during a logic low voltage on the remote on/off pin, and off during a logic high. To turn the power module on and off, the user must supply a switch to control the voltage between the on/off terminal and the -Vin terminal. The switch can be an open collector or equivalent. A logic low is 0V to 1.2V. A logic high is 3.5V to 12V. The maximum source current at the on/off terminal (Pin 2) during a logic high is 500 μ A.

Overload Protection

To provide hiccup mode protection in a fault (output overload) condition, the unit is equipped with internal current limiting circuitry and can endure overload for an unlimited duration.

Overvoltage Protection

The output overvoltage clamp consists of control circuitry, which is independent of the primary regulation loop, that monitors the voltage on the output terminals. The control loop of the clamp has a higher voltage set point than the primary loop. This provides a redundant voltage control that reduces the risk of output overvoltage. The OVP level can be found in the output data.

Output Ripple Reduction

A good quality low ESR capacitor placed as close as practicable across the load will give the best ripple and noise performance. To reduce output ripple, it is recommended to use 4.7 μ F capacitors at the output.

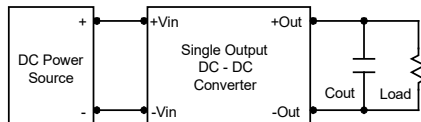

Maximum Capacitive Load

The MRZ1150 series has limitation of maximum connected capacitance at the output. The power module may be operated in current limiting mode during start-up, affecting the ramp-up and the startup time. The maximum capacitance can be found in the data sheet.

Thermal Considerations

Many conditions affect the thermal performance of the power module, such as orientation, airflow over the module and board spacing. To avoid exceeding the maximum temperature rating of the components inside the power module, the baseplate temperature must be kept below 105°C. The derating curves are determined from measurements obtained in a test setup.

