

## FEATURES

- ▶ 2" x 1" x 0.4" Metal Package
- ▶ Wide 2:1 Input Range
- ▶ Very High Efficiency up to 88%
- ▶ Adjustable Output Voltage
- ▶ Operating Temp. Range -40°C to +85°C
- ▶ Short Circuit Protection
- ▶ I/O-isolation 1500VDC
- ▶ Remote on/off (Option)
- ▶ Heatsink (Option)
- ▶ Cost optimized Design
- ▶ CSA/UL/IEC/EN 60950-1 Safety Approval
- ▶ 3 Years Product Warranty



## PRODUCT OVERVIEW

The MINMAX MKW5000 series is a range of isolated 30W DC/DC converter modules featuring fully regulated output voltages and wide 2:1 input voltage ranges. The product comes in a 2" x 1" x 0.4" metal package with industry standard pinout. An excellent efficiency allows an operating temperature range of -40°C to +85°C.

These DC/DC converters offer an economical solution for many cost critical applications in battery-powered equipment and instrumentation.

### Model Selection Guide

Model Number	Input Voltage (Range) VDC	Output Voltage VDC	Output Current		Input Current		Reflected Ripple Current mA(typ.)	Max. capacitive Load µF	Efficiency (typ.) @Max. Load %	
			Max.	Min.	@Max. Load	@No Load				
			mA	mA	mA(typ.)	mA(typ.)				
MKW5030	24 (18 ~ 36)	2.5	6000	0	744	70	100	6800	84	
MKW5031		3.3	6000	0	959				86	
MKW5032		5	5000	0	1185				88	
MKW5039		5.1	5000	0	1207				88	
MKW5033		12	2500	166	1420				680	88
MKW5034		15	2000	133	1420					88
MKW5040	2.5	6000	0	372	50	50	6800	84		
MKW5041	3.3	6000	0	480				86		
MKW5042	5	5000	0	604				88		
MKW5049	5.1	5000	0	604				88		
MKW5043	12	2500	166	710				680	88	
MKW5044	15	2000	133	710					88	

### Input Specifications

Parameter	Model	Min.	Typ.	Max.	Unit
Input Surge Voltage (1 sec. max.)	24V Input Models	-0.7	---	50	VDC
	48V Input Models	-0.7	---	100	
Start-Up Threshold Voltage	24V Input Models	17	17.8	18	
	48V Input Models	34	35	36	
Under Voltage Shutdown	24V Input Models	16	16.5	17	
	48V Input Models	32	33	34	
Reverse Polarity Input Current	All Models	---	---	2	A
Short Circuit Input Power		---	---	4500	mW
Internal Power Dissipation		---	---	4500	mW
Conducted EMI (with suffix A only)		Compliance to EN 55022, class A and FCC part 15, class A			

**Output Specifications**

Parameter	Conditions	Min.	Typ.	Max.	Unit
Output Voltage Setting Accuracy	At 50% Load and Nominal Vin	---	---	±1.0	%Vnom.
Line Regulation	Vin=Min. to Max.	---	±0.1	±0.3	%
Load Regulation (2.5/3.3/5/5.1Vout)	Io=0% to 100%	---	±0.5	±1.0	%
Load Regulation (12/15Vout)	Io=10% to 100%	---	±0.5	±1.0	%
Ripple & Noise (20MHz)		---	75	100	mV <sub>P-P</sub>
Transient Recovery Time	25% Load Step Change	---	200	500	μsec
Transient Response Deviation		---	±2	±4	%
Temperature Coefficient		---	±0.01	±0.02	%/°C
Over Load Protection	Foldback	110	155	---	%
Short Circuit Protection		Continuous			

**General Specifications**

Parameter	Conditions	Min.	Typ.	Max.	Unit
I/O Isolation Voltage (rated)	60 Seconds	1500	---	---	VDC
I/O Isolation Resistance	500 VDC	1000	---	---	MΩ
I/O Isolation Capacitance	100KHz, 1V	---	1200	1500	pF
Switching Frequency		280	350	400	KHz
MTBF (calculated)	MIL-HDBK-217F@25°C, Ground Benign	600,000	---	---	Hours
Safety Approvals	UL/cUL 60950-1 recognition(CSA certificate), IEC/EN 60950-1(CB-scheme)				

**Input Fuse**

24V Input Models	48V Input Models
3000mA Slow-Blow Type	1500mA Slow-Blow Type

**Remote On/Off Control**

Parameter	Conditions	Min.	Typ.	Max.	Unit
Converter On	2.5 to 100VDC or Open Circuit				
Converter Off	-1V ~ 1V or Short Circuit				
Control Input Current (on)	Vctrl = 5.0V	---	---	5	μA
Control Input Current (off)	Vctrl = 0V	---	---	-100	μA
Control Common	Referenced to Negative Input				
Standby Input Current	Nominal Vin	---	2	5	mA

**Environmental Specifications**

Parameter	Conditions	Min.	Max.	Unit
Operating Ambient Temperature Range (See Power Derating Curve)	Natural Convection	-40	+85	°C
Case Temperature		---	+105	°C
Storage Temperature Range		-50	+125	°C
Humidity (non condensing)		---	95	% rel. H
Cooling	Free-Air convection			
Lead Temperature (1.5mm from case for 10Sec.)		---	260	°C

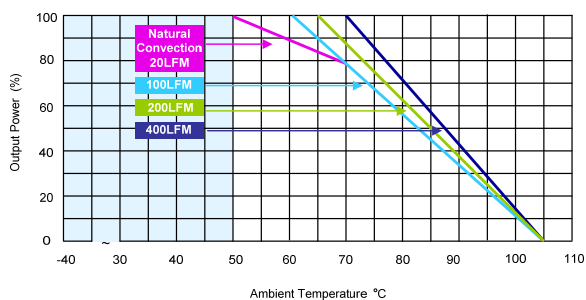
**Power Derating Curve**

Derating Curve without Heatsink

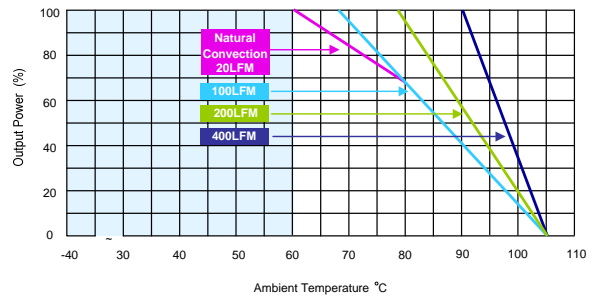

Derating Curve with Heatsink

**Notes**

- 1 Specifications typical at Ta=+25°C, resistive load, nominal input voltage and rated output current unless otherwise noted.
- 2 Transient recovery time is measured to within 1% error band for a step change in output load of 75% to 100%
- 3 Ripple & Noise measurement bandwidth is 0-20MHz.
- 4 These power converters require a minimum output loading to maintain specified regulation, operation under no-load conditions will not damage these modules; however they may not meet all specifications listed.
- 5 All DC/DC converters should be externally fused at the front end for protection.
- 6 Other input and output voltage may be available, please contact factory.
- 7 To order the converter with Remote On/Off function, please add **suffix RC** (e.g. MKW5030-RC) to order code.
- 8 To order the converter with EN55022 Class A, please add **suffix A** (e.g. MKW5030A) to order code.
- 9 To order the converter with heatsink, please add **suffix H** (e.g. MKW5030H) to order code.
- 10 That "natural convection" is about 20LFM but is not equal to still air (0 LFM).
- 11 Specifications are subject to change without notice.

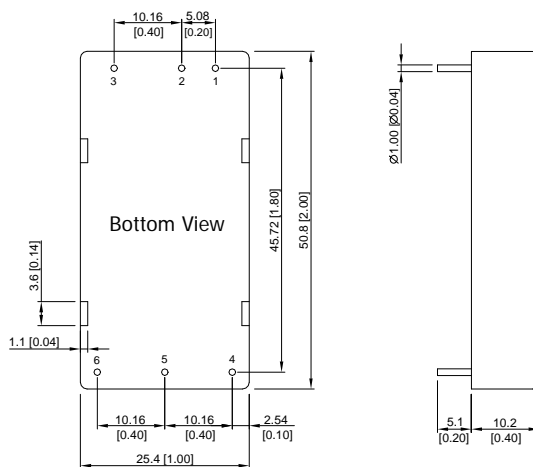
**Package Specifications**
**Mechanical Dimensions**

**Pin Connections**

Pin	Function
1	+Vin
2	-Vin
3	Remote On/Off
4	+Vout
5	-Vout
6	Trim

- ▶ All dimensions in mm (inches)
- ▶ Tolerance: X.X±0.25 (X.XX±0.01)  
X.XX±0.13 (X.XXX±0.005)
- ▶ Pin diameter  $\varnothing$  1.0 ±0.05 (0.04±0.002)

**Physical Characteristics**

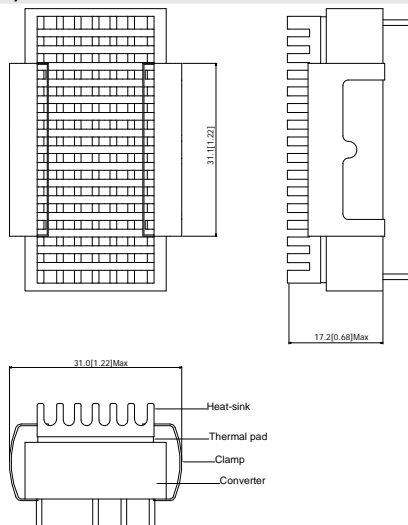
Case Size	: 50.8x25.4x10.2mm (2.0x1.0x0.40 inches)
Case Material	: Aluminum Anodizing Treatment in Black
Base Material	: FR4 PCB (flammability to UL 94V-0 rated)
Pin Material	: Copper Alloy with Gold Plate Over Nickel Subplate
Weight	: 32g

**Heatsink (Option -H)**

**Physical Characteristics**

Heatsink Material	: Aluminum
Finish	: Black Anodized Coating
Weight	: 9g

- ▶ The advantages of adding a heatsink are:
  1. To help heat dissipation and increase the stability and reliability of DC/DC converters at high operating temperature atmosphere.
  2. To upgrade the operating temperature of DC/DC converters, please refer to Derating Curve.

## Test Setup

### Input Reflected-Ripple Current Test Setup

Input reflected-ripple current is measured with an inductor  $L_{in}$  (4.7 $\mu$ H) and  $C_{in}$  (220 $\mu$ F, ESR < 1.0 $\Omega$  at 100 KHz) to simulate source impedance. Capacitor  $C_{in}$ , offsets possible battery impedance. Current ripple is measured at the input terminals of the module, measurement bandwidth is 0-500 KHz.

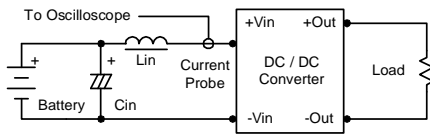

### Peak-to-Peak Output Noise Measurement Test

Use a  $C_{out}$  1.0 $\mu$ F ceramic capacitor. Scope measurement should be made by using a BNC socket, measurement bandwidth is 0-20 MHz. Position the load between 50 mm and 75 mm from the DC/DC Converter.

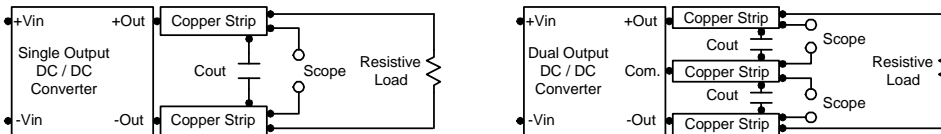

## Technical Notes

### Remote On/Off

Positive logic remote on/off turns the module on during a logic high voltage on the remote on/off pin, and off during a logic low. To turn the power module on and off, the user must supply a switch to control the voltage between the on/off terminal and the -Vin terminal. The switch can be an open collector or equivalent.

A logic low is -1V to 1.0V. A logic high is 2.5V to 100V. The maximum sink current at the on/off terminal (Pin 3) during a logic low is -100 $\mu$ A.

The maximum allowable leakage current of a switch connected to the on/off terminal (Pin 3) at logic high (2.5V to 100V) is 5 $\mu$ A.

### Output Voltage Trim

Output voltage trim allows the user to increase or decrease the output voltage set point of a module.

The output voltage can be adjusted by placing an external resistor ( $R_{adj}$ ) between the Trim and +Vout or -Vout terminals. By adjusting  $R_{adj}$ , the output voltage can be change by  $\pm 10\%$  of the nominal output voltage.

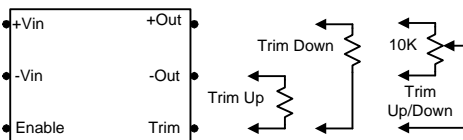

A 10K, 1 or 10 Turn trimpot is usually specified for continuous trimming. Trim pin may be safely left floating if it is not used.

Connecting the external resistor ( $R_{adj-up}$ ) between the Trim and -Vout pins increases the output voltage to set the point as defined in the following equation:

$$R_{adj-up} = \frac{(33 \times V_{out}) - (30 \times V_{adj})}{V_{adj} - V_{out}}$$

Connecting the external resistor ( $R_{adj-down}$ ) between the Trim and +Vout pins decreases the output voltage set point as defined in the following equation:

$$R_{adj-down} = \frac{(36.667 \times V_{adj}) - (33 \times V_{out})}{V_{out} - V_{adj}}$$

$V_{out}$ : Nominal Output Voltage     $V_{adj}$ : Adjusted Output Voltage    Units: VDC/ K $\Omega$

### Overcurrent Protection

To provide protection in a fault (output overload) condition, the unit is equipped with internal current limiting circuitry and can endure current limiting for an unlimited duration. At the point of current-limit inception, the unit shifts from voltage control to current control. The unit operates normally once the output current is brought back into its specified range.

### Overvoltage Protection

The output overvoltage clamp consists of control circuitry, which is independent of the primary regulation loop, that monitors the voltage on the output terminals. The control loop of the clamp has a higher voltage set point than the primary loop. This provides a redundant voltage control that reduces the risk of output overvoltage. The OVP level can be found in the output data.

**Input Source Impedance**

The power module should be connected to a low ac-impedance input source. Highly inductive source impedances can affect the stability of the power module. In applications where power is supplied over long lines and output loading is high, it may be necessary to use a capacitor at the input to ensure startup. Capacitor mounted close to the power module helps ensure stability of the unit, it is recommended to use a good quality low Equivalent Series Resistance (ESR < 1.0Ω at 100 KHz) capacitor of a 33μF for the 12V input devices and a 10μF for the 24V and 48V devices.

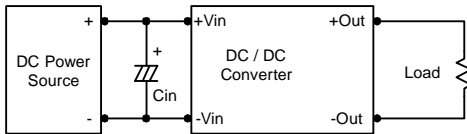
**Output Ripple Reduction**

A good quality low ESR capacitor placed as close as practicable across the load will give the best ripple and noise performance. To reduce output ripple, it is recommended to use 4.7μF capacitors at the output.

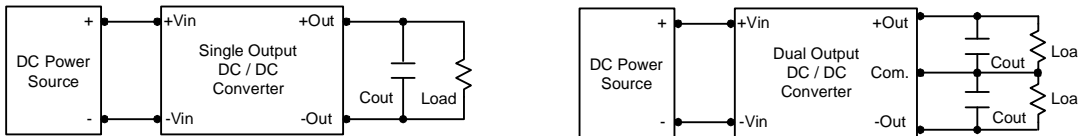
**Maximum Capacitive Load**

The MKW5000 series has limitation of maximum connected capacitance at the output. The power module may be operated in current limiting mode during start-up, affecting the ramp-up and the startup time. For optimum performance we recommend 680μF maximum capacitive load for 12V & 15V outputs and 6800μF capacitive load for the other outputs. The maximum capacitance can be found in the data sheet.

**Thermal Considerations**

Many conditions affect the thermal performance of the power module, such as orientation, airflow over the module and board spacing. To avoid exceeding the maximum temperature rating of the components inside the power module, the case temperature must be kept below 105°C.

The derating curves are determined from measurements obtained in a test setup.

